

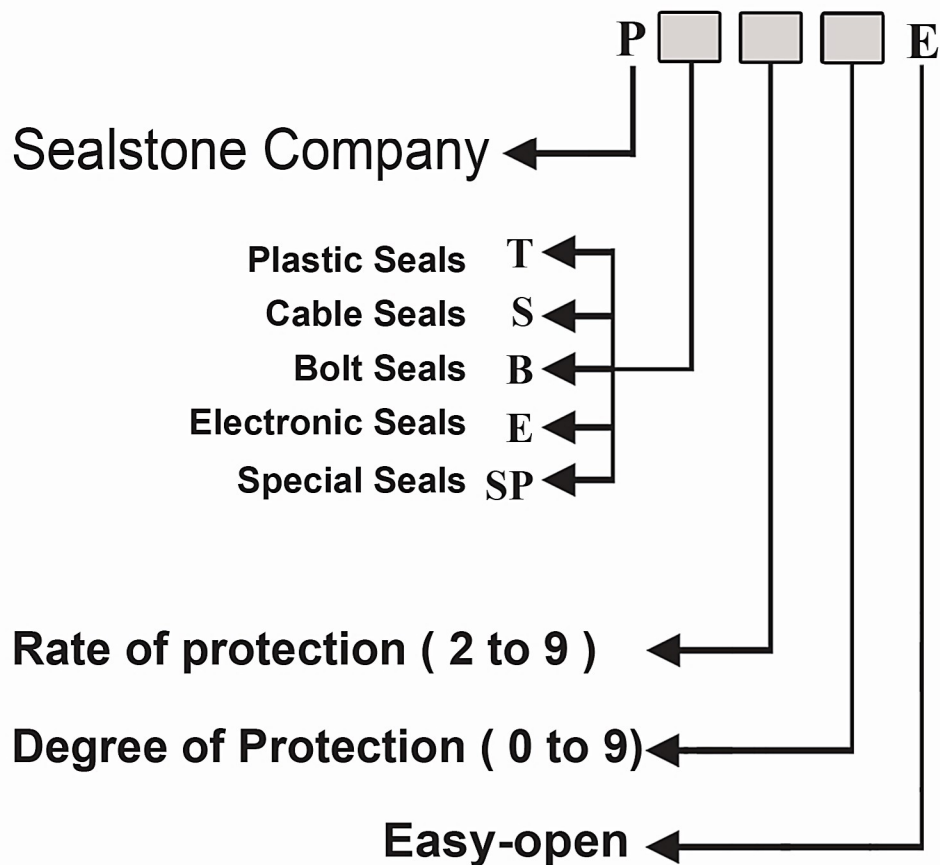

Sealstone Company

Guide to product code identification
by name, resistance and safety



PT20 Seal

Plastic seal with 'weak' degree of protection
Laser-printed and hot stamped logo, name and serial number.

Material: PP/PE

Average tensile strength: 10 kg

Packing: 100 pcs per vacuum / 1000 seals per carton

Applications: Seals for warehouses, bags, airbags, fire extinguishers, etc.

Color variation: 

Other colors are available on request.

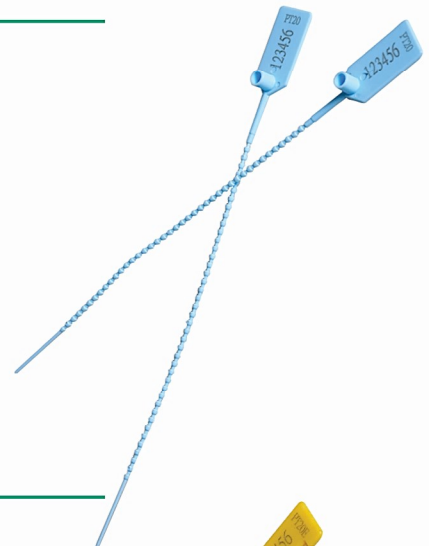
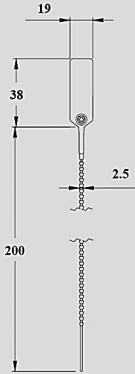

PT20E Seal

Easy-open plastic seal with 'weak' degree of protection, Laser-printed and hot stamped logo name and serial number.

Material: PP/PE

Average tensile strength: 10 kg

Packing: 100 pcs per vacuum / 1000 seals per carton

Applications: Warehouses, Bags, Airline, Fire Extinguishers, etc.

Color Variation: 

Other colors are available on request.

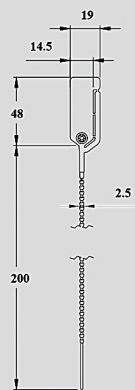

PT22 Seal

Plastic seal with 'weak' degree of protection
Laser-printed and hot stamped logo, name and serial number.

Material: PP/PE

Average tensile strength: 15 kg

Packing: 100 pcs per vacuum / 1000 seals per carton

Applications: Warehouses, Airline, Fire Extinguishers, etc.

Color variation: 

Other colors are available on request.

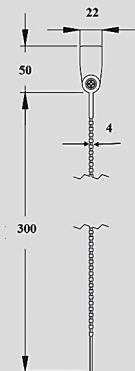

PT22E Seal

Easy-open plastic seal with 'weak' degree of protection, Laser-printed and hot stamped logo, name and serial number.

Material: PP/PE

Average tensile strength: 15 kg

Packing: 100 pcs per vacuum / 1000 seals per carton

Applications: Warehouses, Bags, Airline, Fire Extinguishers, etc.

Color Variation: 

Other colors are available on request.

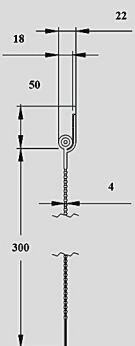

Seal PT23



Plastic seal with 'weak' degree of protection
Laser-printed and hot stamped logo, name and serial number.

Material: PP/PE

Average tensile strength: 15 kg

Packing: 100 pcs per vacuum / 1000 seals per carton

Applications: Warehouses, Bags, Airline, Fire Extinguishers, etc.

Color variation:

Other colors are available on request.

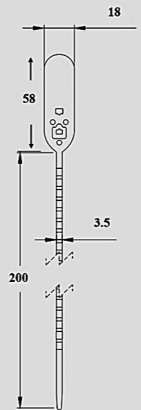

Seal PT23E



Easy-open plastic seal with 'weak' degree of protection, Laser-printed and hot stamped logo, name and serial number.

Material: PP/PE

Average tensile strength: 15 kg

Packing: 100 pcs per vacuum / 1000 seals per carton

Applications: Warehouses, Bags, Airline, Fire Extinguishers, etc.

Color Variation:

Other colors are available on request.

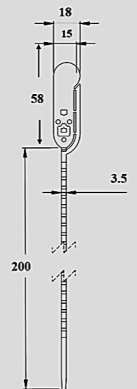

Seal PT24



Plastic seal with 'weak' degree of protection
Laser-printed and hot stamped logo, name and serial number.

Material: PP/PE

Average tensile strength: 25 kg

Packing: 100 pcs per vacuum / 1000 seals per carton

Applications: Warehouses, Bags, Airline, Fire Extinguishers and Post Bags

Color variation:

Other colors are available on request.

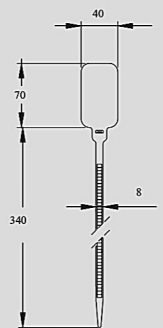

Seal PT26



Plastic seal with 'weak' degree of protection
Laser-printed and hot stamped logo, name and serial number.

Material: PP/PE

Average tensile strength: 25 kg

Packing: 100 pcs per vacuum / 1000 seals per carton

Applications: Warehouses, Bags, Airline, Fire Extinguishers and Post Bags

Color variation:

Other colors are available on request.

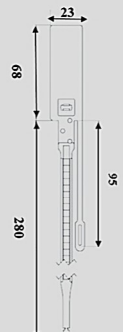

PT27 Seal

Plastic seal with 'weak' degree of protection
Laser-printed and hot stamped logo, name and serial number.

Material: PP/PE

Average tensile strength: 25 kg

Packing: 100 pcs per vacuum / 1000 seals per carton

Applications: Warehouses, Bags, Airline, Fire Extinguishers and Post Bags

Color variation: 

Other colors are available on request.

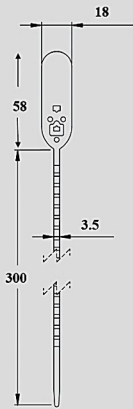

PT27E Seal

Easy-open plastic seal with 'weak' degree of protection, Laser-printed and hot stamped logo, name and serial number.

Material: PP/PE

Average tensile strength: 20 kg

Packing: 100 pcs per vacuum / 1000 seals per carton

Applications: Warehouses, Bags, Airline, Fire Extinguishers, etc.

Color Variation: 

Other colors are available on request.

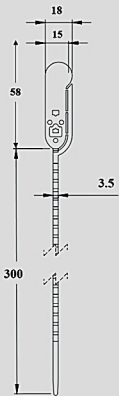

PT28E Seal

Easy-open plastic seal with 'weak' degree of protection, Laser-printed and hot stamped logo, name and serial number.

Material: PP/PE

Average tensile strength: 25 kg

Packing: 100 pcs per vacuum / 1000 seals per carton

Applications: Warehouses, Bags, Airline, Fire Extinguishers and Post Bags...

Color Variation: 

Other colors are available on request.



PT30 Seal

Metal seal with 'medium' degree of protection
Laser-printed logo, name and serial number.

Material: Tin plated or galvanized sheet

Average tensile strength: 70 kg

Packing: Vacuum cleaners 100 pcs / 1000 cartons

Applications: Warehouses, Containers, Tanks Wagons, etc.

Color Variation: 

Other colors are available on request.

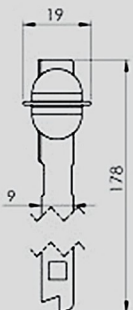

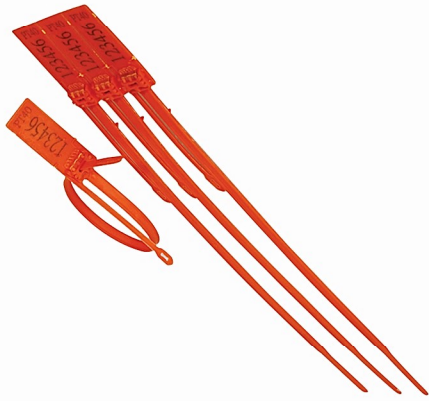

Seal PT40

Plastic seal with 'medium' degree of protection
Laser-printed and hot stamped logo, name and serial number.

Material: PP / PE with stainless steel lock

Average tensile strength: 30 kg

Packing: 100 pcs per vacuum / 1000 seals per carton

Applications: Warehouses, Bags Airline, Post Bags, etc.

Color Variation:

Other colors are available on request.

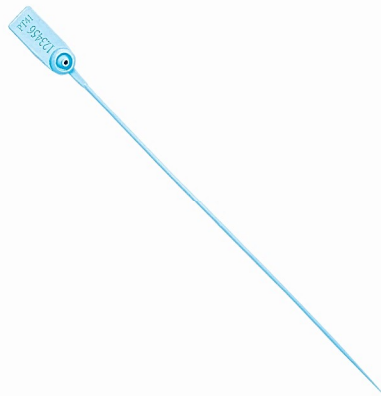
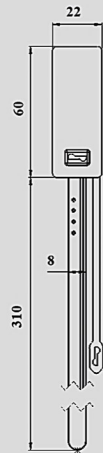

Seal PT41

Plastic seal with 'medium' degree of protection
Laser-printed and hot stamped logo, name and serial number.

Material: PP / PE with stainless steel lock

Average tensile strength: 20 kg

Packing: 100 pcs per vacuum / 1000 seals per carton

Applications: Warehouses, Bags, Containers Wagons ...

Color Variation:

Other colors are available on request.

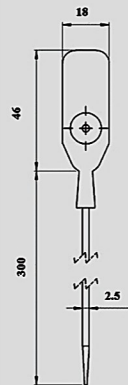

Seal PT42

Plastic seal with 'medium' degree of protection
Laser-printed and hot stamped logo, name and serial number.

Material: PP / PE with stainless steel lock

Average tensile strength: 20 kg

Packing: 100 pcs per vacuum / 1000 seals per carton

Applications: Warehouses, Bags, Containers Wagons ...

Color Variation:

Other colors are available on request.

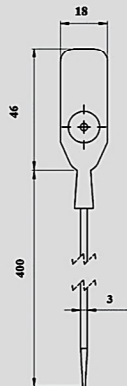

Seal PT43

Plastic seal with 'medium' degree of protection
Laser-printed and hot stamped logo, name and serial number.

Material: PP / PE with stainless steel lock

Average tensile strength: 25 kg

Packing: 100 pcs per vacuum / 1000 seals per carton

Applications: Warehouses, Bags, Containers Wagons ...

Color Variation:

Other colors are available on request.

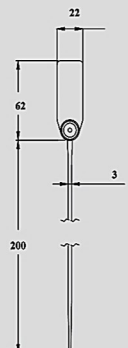

PT43E Seal

Easy-open plastic seal with 'medium' degree of protection, Laser-printed and hot stamped logo, name and serial number.

Material: PP / PE with stainless steel lock

Average tensile strength: 25 kg

Packing: 100 pcs per vacuum / 1000 seals per carton

Applications: Warehouses, Bags, Containers Wagons ...

Color Variation: 

Other colors are available on request.

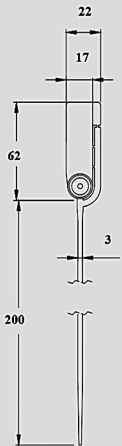

PT44 Seal

Plastic seal with 'medium' degree of protection Laser-printed and hot stamped logo, name and serial number.

Material: PP / PE with stainless steel lock

Average tensile strength: 25 kg

Packing: 100 pcs per vacuum / 1000 seals per carton

Applications: Warehouses, Bags, Containers Wagons ...

Color Variation: 

Other colors are available on request.

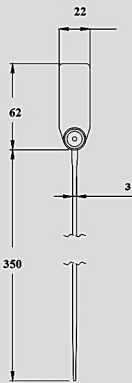
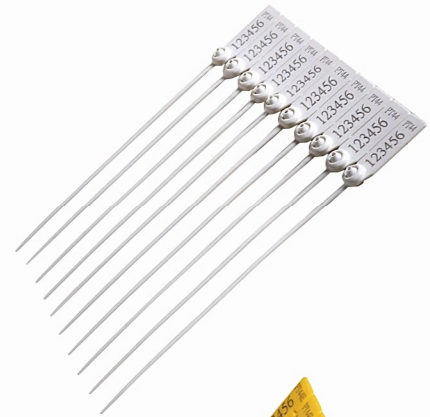

PT44E Seal

Easy-open plastic seal with 'medium' degree of protection, Laser-printed and hot stamped logo, name and serial number.

Material: PP / PE with stainless steel lock

Average tensile strength: 25 kg

Packing: 100 pcs per vacuum / 1000 seals per carton

Applications: Warehouses, Bags, Containers Wagons ...

Color Variation: 

Other colors are available on request.

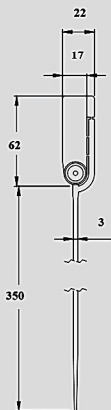
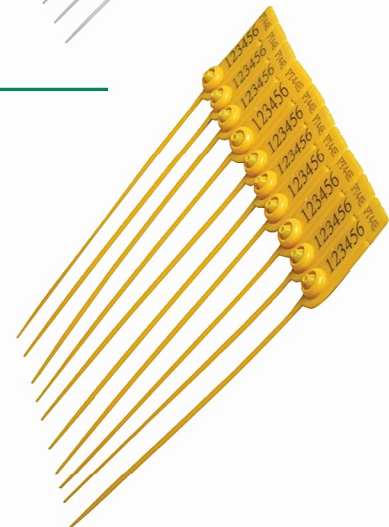

PT45 Seal

Plastic seal with 'medium' degree of protection Laser-printed and hot stamped logo, name and serial number.

Material: PP / PE with stainless steel lock

Average tensile strength: 25 kg

Packing: 100 pcs per vacuum / 1000 seals per carton

Applications: Warehouses, Bags, Containers Wagons ...

Color Variation: 

Other colors are available on request.

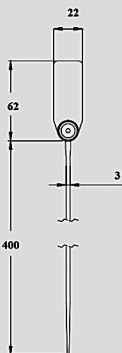
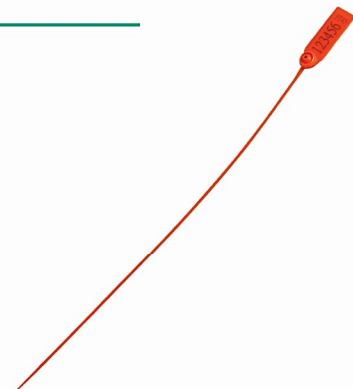

Seal PT45E

Easy-open plastic seal with 'medium' degree of protection, Laser-printed and hot stamped logo, name and serial number.

Material: PP / PE with stainless steel lock

Average tensile strength: 25 kg

Packing: Vacuum cleaners 100 pcs / 1000 cartons

Applications: Warehouses, Bags, Containers Wagons ...

Color Variation: 

Other colors are available on request.

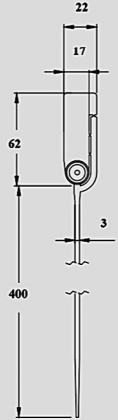

Seal PT46

Plastic seal with 'medium' degree of protection Laser-printed and hot stamped logo, name and serial number.

Material: PP/PE/PC with stainless steel lock

Average tensile strength: 20 kg

Packing: Vacuum cleaners 100 pcs / 1000 cartons

Applications: Warehouses, Bags, Containers Wagons ...

Color Variation: 

Other colors are available on request.

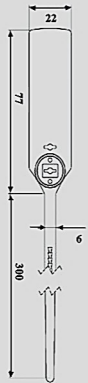

Seal PT47E

Easy-open plastic seal with 'medium' degree of protection, Laser-printed and hot stamped logo, name and serial number.

Material: PP / PE with stainless steel lock

Average tensile strength: 20 kg

Packing: 100 pcs per vacuum / 1000 seals per carton

Applications: Warehouses, Bags, Airline, Post Bags and ...

Color Variation: 

Other colors are available on request.

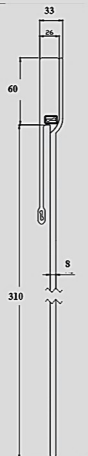

Seal PT48

Plastic seal with 'medium' degree of protection Laser-printed and hot stamped logo, name and serial number.

Material: PP / PE with stainless steel lock

Average tensile strength: 45 kg

Packing: 100 pcs per vacuum / 1000 seals per carton

Applications: Warehouses, Bags, Ballot Box Cement Bunker ...

Color Variation: 

Other colors are available on request.

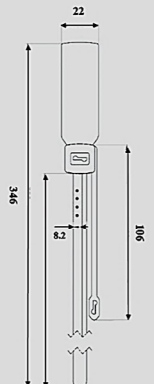

PT49 Seal

Plastic seal with 'medium' degree of protection
Laser-printed and hot stamped logo, name and serial number.

Material: PP / PE with stainless steel lock

Average tensile strength: 45 kg

Packing: 100 pcs per vacuum / 1000 seals per carton

Applications: Warehouses, Bags, Ballot Box
Cement Bunker ...

Color Variation: 

Other colors are available on request.

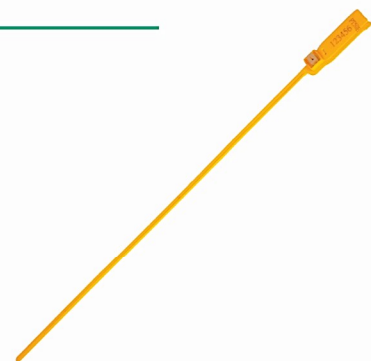

PT49E Seal

Easy-open plastic seal with 'medium' degree of protection, Laser-printed and hot stamped logo, name and serial number.

Material: PP / PE with stainless steel lock

Average tensile strength: 45 kg

Packing: 100 pcs per vacuum / 1000 seals per carton

Applications: Warehouses, Bags, Ballot Box
Cement Bunker ...

Color Variation: 

Other colors are available on request.

PT50 Seal

Plastic seal with 'medium' degree of protection
Laser-printed and hot stamped logo, name and serial number.

Material: PP / PE with stainless steel lock

Average tensile strength: 45 kg

Packing: 100 pcs per vacuum / 1000 seals per carton

Applications: Warehouses, Bags, Ballot Box
Cement Bunker ...

Color Variation: 

Other colors are available on request.

PT50E Seal

Easy-open plastic seal with 'medium' degree of protection, Laser-printed and hot stamped logo, name and serial number.

Material: PP / PE with stainless steel lock

Average tensile strength: 45 kg

Packing: 100 pcs per vacuum / 1000 seals per carton

Applications: Warehouses, Bags, Ballot Box
Cement Bunker ...

Color Variation: 

Other colors are available on request.

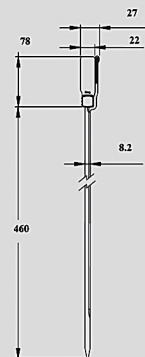
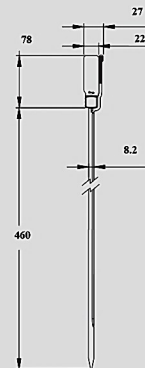
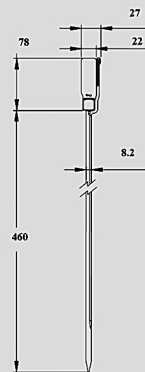
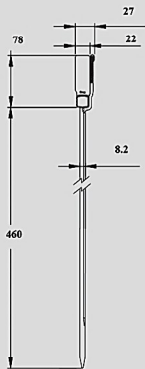

Seal PS60

Twister seal with 'very strong' degree of protection
Laser-printed logo, name and serial number.
Material: PC / ABS and stainless steel wire with 0.7 mm diameter

Average tensile strength: 450 kg

Packing: 20 pcs per vacuum / 1000 seals per carton

Applications: Meters, entrance and exit doors, etc.

Color Variation: 

Other colors are available on request.

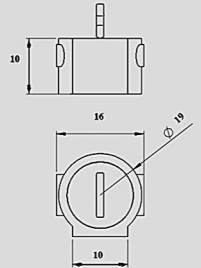

Seal PS61

Twister seal with 'very strong' degree of protection
Laser-printed logo, name and serial number.
Material: PC / ABS and stainless steel wire with 0.7 mm diameter

Average tensile strength: 20 kg

Packing: 20 pcs per vacuum / 1000 seals per carton

Applications: Meters, entrance and exit doors, etc.

Color Variation: 

Other colors are available on request.

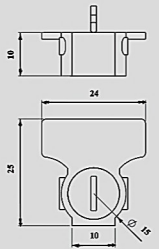

Seal PS65

Twister seal with 'very strong' degree of protection
Laser-printed logo, name and serial number.
Material: PC / ABS and stainless steel wire with 0.7 mm diameter

Average tensile strength: 20 kg

Packing: 20 pcs per vacuum / 1000 seals per carton

Applications: Meters, entrance and exit doors, etc.

Color Variation: 

Other colors are available on request.

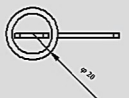

Seal PS66

Cable seal with 'strong' degree of protection
Laser-printed logo, name and serial number.
Material: Zinc alloy and galvanized steel cable with a diameter of 1.2 mm

Average tensile strength: 150 kg

Packing: 25 pcs per vacuum / 1000 seals per carton

Applications: Entrance and Exit doors, Warehouses
Wagons, etc.

Color Variation: 

Other colors are available on request.



PS70 Seal

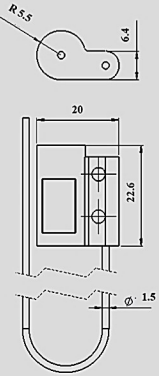

Cable seal with 'strong' degree of protection
Laser-printed logo, name and serial number.

Material: Zinc alloy and galvanized steel cable with a diameter of 1.5 mm

Average tensile strength: 300 kg

Packing: 25 pcs per vacuum / 500 seals per carton

Applications: Meters, Entrance and Exit doors
Warehouses, Fuel Tanks, etc.

Color: 



PS71 Seal

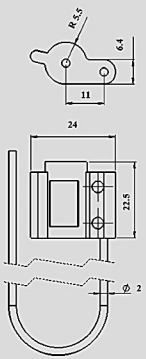

Cable seal with 'strong' degree of protection
Laser-printed logo, name and serial number.

Material: Zinc alloy and galvanized steel cable with a diameter of 2 mm

Average tensile strength: 4500 kg

Packing: 10 pcs per vacuum / 500 seals per carton

Applications: Meters, Entrance and Exit doors
Fuel Tanks, etc.

Color: 



PS75 Seal

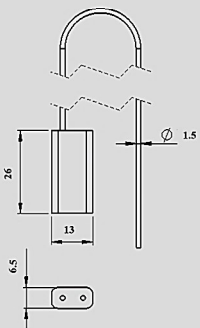

Cable seal with 'very strong' degree of protection
Laser-printed logo, name and serial number

Material: Zinc alloy and galvanized steel cable with diameter 1.2 mm and 1.5 mm

Average tensile strength: 200-300 kg

Packing: 25 pcs per vacuum / 500 seals per carton

Applications: Meters, Entrance and Exit doors
Warehouse, Notary Offices, etc.

Color Variation:     

Other colors are available on request.

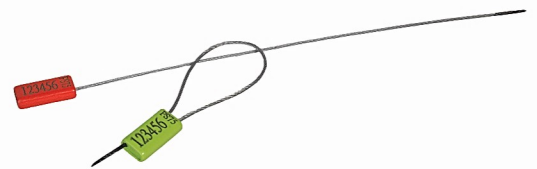

PS76 Seal

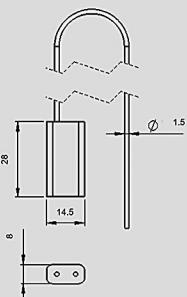

Cable seal with 'very strong' degree of protection
Laser-printed logo, name and serial number

Material: Zinc alloy and galvanized steel cable with diameter 1.2 mm and 1.5 mm

Average tensile strength: 200-300 kg

Packing: 25 pcs per vacuum / 500 seals per carton

Applications: Meters, Entrance and Exit doors
Warehouse, Notary Offices, etc.

Color Variation:     

Other colors are available on request.



Seal PS80

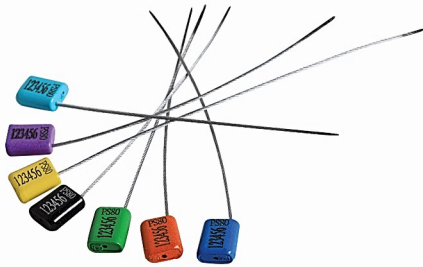

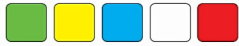
Cable seal with 'very strong' degree of protection
 Laser-printed logo, name and serial number
Material: Zinc alloy and galvanized steel cable with diameter 1.2 mm and 1.5 mm
Average tensile strength: 200-300 kg
Packing: 25 pcs per vacuum / 1000 seals per carton
Applications: Meters, Entrance and Exit doors
 Warehouse, Wagon, Container, Bonker, etc
Color Variation: 
 Other colors are available on request.

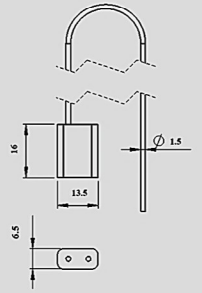

Seal PS82

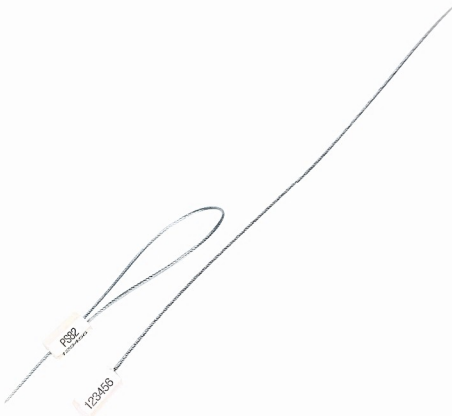

Cable seal with 'very strong' degree of protection
 Laser-printed logo, name and serial number
Material: ABS coated steel lock with 1.7 mm diameter
Average tensile strength: 150 kg
Packing: 20 pcs per vacuum / 500 seals per carton
Applications: Meters, Entrance and Exit doors
 Warehouse, Wagons, Fuel tanks, Containers, etc.
Color Variation: 
 Other colors are available on request.

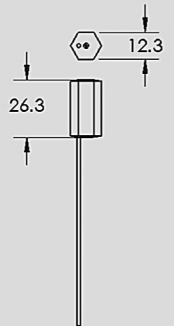

Seal PS84

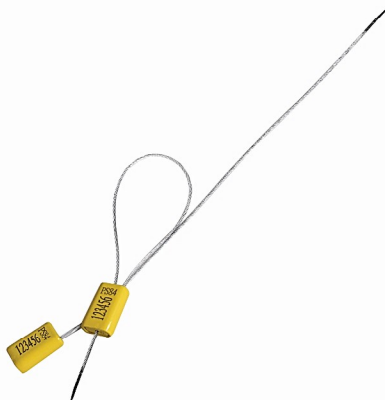

Cable seal with 'very strong' degree of protection
 Laser-printed logo, name and serial number
Material: Zinc alloy and galvanized steel cable with a diameter of 1.5 mm
Average tensile strength: 200-300 kg
Packing: 20 pcs per vacuum / 500 seals per carton
Applications: Meters, Entrance and Exit doors
 Warehouse, Wagon, Container, etc.
Color Variation: 
 Other colors are available on request.

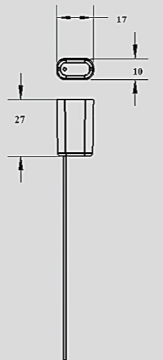

Seal PS85

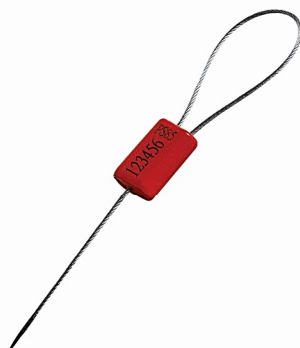

Cable seal with 'very strong' degree of protection
 Laser-printed logo, name and serial number
Material: Zinc alloy and galvanized steel cable with a diameter of 1.5 mm
Average tensile strength: 300 kg
Packing: 20 pcs per vacuum / 500 seals per carton
Applications: Meters, Entrance and Exit doors
 Warehouse, Wagon, Container, etc.
Color Variation: 
 Other colors are available on request.

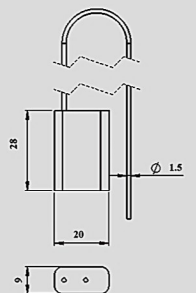

PS88 Seal

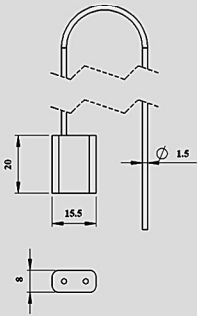

Cable seal with 'very strong' degree of protection Laser -printed and hot stamped logo, name and serial number.

Material: Zinc alloy and galvanized steel cable with a diameter of 1.2 mm and 1.5 mm and polycarbonate coating

Average tensile strength: 200-300 kg

Packing: 20 pcs per vacuum / 1000 seals per carton

Applications: Meters, Entrance and Exit doors Warehouses, Wagons, Weighing systems, etc.

Color Variation:

Other colors are available on request.



PS90 Seal

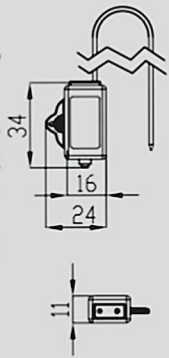

Cable seal with 'very strong' degree of protection Laser-printed logo, name and serial number RFID TAG includes curved input for wire incorporation

Material: Zinc alloy with PP/ABS Coated and galvanized steel cable with a diameter of 2.1 mm

Average tensile strength: 200 kg

Packing: 20 pcs per vacuum / 500 seals per carton

Applications: Meters, Tank doors, Fuel, Warehouse Container, Wagon, etc.

Color Variation: Colors can be customized

This product is owned by the ministry of petroleum.



PS95 Seal

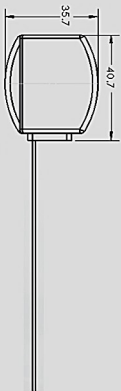

Cable seal with multi lock mechanism and 'very good' strong degree of protection, Fiber laser-printed, RFID TAG, with a patent certificate

Material: Polyamide fiber, polypropylene and galvanized steel cable 1.2 mm in diameter

Average tensile strength: 150-200 kg

Packing: 20 pcs per vacuum / 500 seals per carton

Applications: Meters, Entrance and Exit doors Warehouse, Wagon, Container, Bonker, etc.

Color Variation:

Other colors are available on request.



PB90 Seal

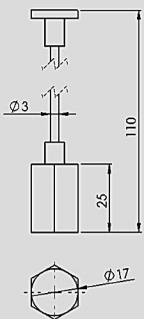

Combined adjustable length Bolt seal with 'very strong' degree of protection, Laser-printed logo, name and serial number.

Material: Steel or plated steel body with 1mm diameter cable

Average tensile strength: 450 kg

Packing: 10 pcs per vacuum / 200 seals per carton

Applications: Warehouse, Containers, Trucks Tankers, Bunkers, Freight Wagons



Seal PB91



Bolt seal with 'very strong' degree of protection
Laser-printed and hot stamped logo, name and serial number.

Material: ABS Steel body plated with polypropylene coating

Average tensile strength: 1 Ton

Packing: 10 pcs per vacuum / 200 seals per carton

Applications: Warehouse, Container, Truck Tanker, Bunker, Wagon and Fuel

Color Variation:

Other colors are available on request.

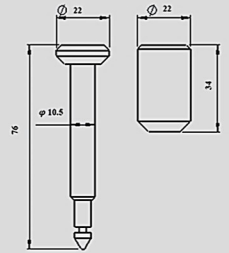

Seal PB92



Bolt seal with 'very strong' degree of protection
Laser-printed and hot stamped logo, name and serial number.

Material: ABS laminated steel body

Average tensile strength: 450 kg

Packing: 10 pcs per vacuum / 200 seals per carton

Applications: Warehouse, Containers, Trucks Tankers, Bunkers, Freight Wagons, etc.

Color Variation:

Other colors are available on request.

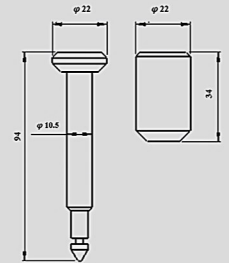

Seal PB93



Adjustable length Bolt seal by 'very strong' degree of protection adjustable seal with "very good" degree of protection, Laser-printed and hot stamped logo, name and serial number.

Material: Aluminum body with 2.5mm diameter polypropylene coated steel cable

Average tensile strength: 1 Ton

Packing: 10 pcs per vacuum / 200 seals per carton

Applications: Warehouse, Containers, Trucks Tankers, Bunkers, Freight Wagons, etc.

Color Variation:

Other colors are available on request.

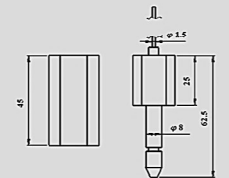

Seal PB94



Bolt seal with 'very strong' degree of protection
Laser-printed and hot stamped logo, name and serial number.

Material: ABS laminated steel body

Average tensile strength: 1 Ton

Packing: 10 pcs per vacuum / 200 seals per carton

Applications: Warehouse, Containers, Trucks Tankers, Bunkers, Freight Wagons, etc.

Color Variation:

Other colors are available on request.

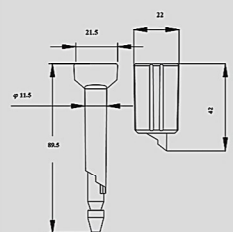

PE100 Seal

Electromechanical seal with 'excellent' degree of protection, Laser-printed and hot stamped logo, name and serial number.

Material: ABS/PC Metal part, plastic, electronic

Applications: Container, Wagon with extremely sensitive security grade

Color Variation:

Other colors are available on request.



PE120 Seal

Electromechanical seal with 'excellent' degree of protection, Laser-printed and hot stamped logo, name and serial number, Patent certificate.

Material: ABS/PC Metal part, plastic, electronic

Applications: Container, Wagon with extremely sensitive security grade

Color Variation:

Other colors are available on request.



PSP Seal

Chamber seal



Livestock Ear Tag



Nail Tag



Chamber seal



Railway Seal



Drum Cap Seal



Plastic security seal pipe lock



Customs Seals



Padlock Seals

